

CALDERA C3

V2020.11



Be ready to RIP!

- Pre-loaded Debian OS & CalderaRIP
- Independent recovery thanks to the included restoration USB stick
- Up to 9% faster on halftone (with Hardware Acceleration) compared to previous C3 V2020.01

THE NEW WORKHORSE



Intel i9

- 10 cores
- 20 threads
- Unlocked 9th generation Coffee Lake



Nvidia P1000

- 4 GB
- GDDR5
- PCI Express 3.0x16

Non-Volatile Memory Express (NVMe)

Interface for SSD on PCIe

- 3x times faster than SATA SSD

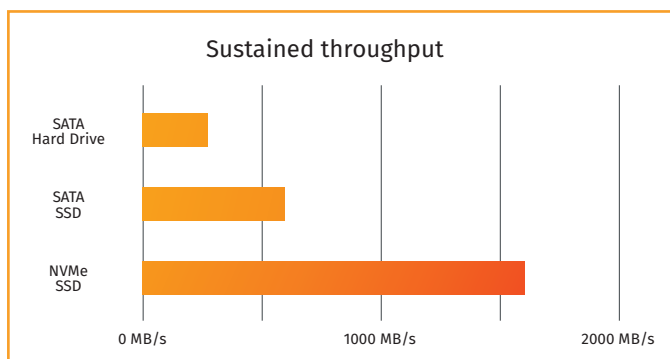

DELL ProSupport Included

3 year warranty

Phone support 24h/24 – 365d/year

On site intervention, day after call (ProSupport J+1)



CALDERA C3

V2020.11



SPECIFICATIONS:

Processor	Intel Core i9-10900, 10-Core, 20 Threads, 20 MB, from 2.8 GHz to 5.2 GHz
Memory	16 GB (2 x 8 GB) DDR4 non-ECC 2933 MHz
Hard Drive	SSD 1 TB M.2 PCIe NVMe Class 40 Solid State Drive
Pre-Loaded	Debian OS and Caldera Solutions
Video Card	NVIDIA Quadro P1000, 4 GB, 4mDP to DP adapter - Dual screen supported
Additional card	2nd Intel Gigabit NIC PCIe Card (Full Height)
Optical Drive	No optical drive
Keyboard	Dell USB, AZERTY or US QWERTY
Mouse	Dell USB Mouse
Warranty	3 years, ProSupport and Next Business Day On-Site Service
Package dimensions / weight	48 x 39 x 26 cm / 8 kg

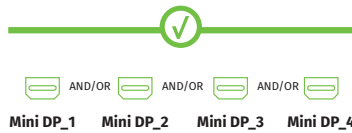

Caldera C3 Dell Precision 3440 SFF



-  Recommended video ports
-  Video ports not recommended
-  USB 3.0

SCREEN'S OUTPUTS



 Caldera C1 / C2 / C3

C3 COMPATIBLE ADAPTORS**

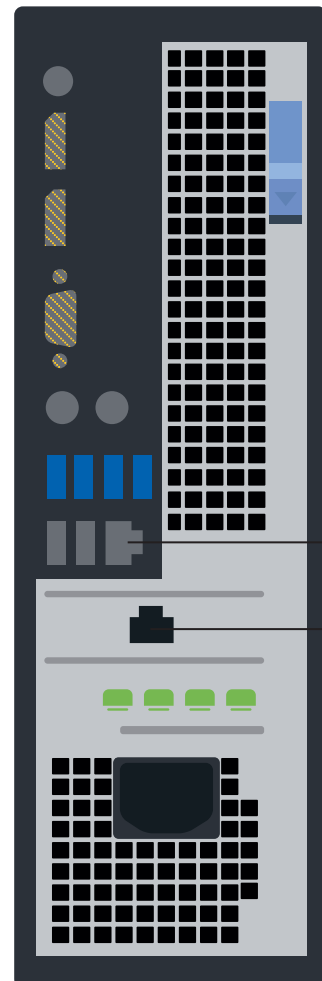
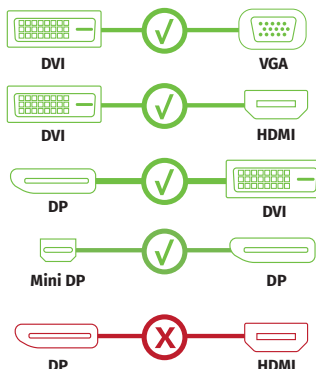

LAN for network intranet & internet

LAN for direct connection with printer

* Dell P2319H not included / ** 4 adaptors MiniDP/DP included